



MILITARY AMMUNITION





World leader in ammunition for portable weapons and one of the main suppliers to NATO, CBC is the premier Defense brand in the small caliber segment. CBC products are used globally and contribute to the protection and security of millions of people.

CBC was created in Brazil in 1926 and holds the status of Strategic Defense Company, being the primary supplier to the local military and law enforcement sectors. It serves as the headquarters for CBC Global Ammunition, the holding for a group of companies internationally active in the ammunition sector: CBC Brazil, Magtech Ammunition USA, MEN Germany and Sellier & Bellot Czech Republic.

This strategic alliance forms one of the largest ammunition corporations in the world, with a combined experience of more than 300 years in the manufacturing of small and medium calibers.

The comprehensive range of CBC products is exported to over 100 countries, meeting the needs of Military, Law Enforcement and Commercial markets.

Together, CBC Global operations employ 3.500 skilled workers and produce over 1.5 billion rounds of ammunition per year.

To learn more about CBC Defense and CBC Global Ammunition, please access cbcdefense.com / cbcglobal-ammunition.com.



CONTENT

SMALL CALIBER

04

9 x 19 mm	06
300 BLACKOUT	07
5.56 x 45 mm	08
7.62 x 51 mm	10
12.7 x 99 mm	12
12.7 x 108 mm	14
SNIPER 1	15

MEDIUM CALIBER

18

20 x 102 mm	20
20 x 128 mm	21
30 x 113 mm	22
30 x 173 mm	23
40 x 53 mm	24

SPECIAL TECHNOLOGIES

26

Reduced Range	28
Infrared Tracer	30
SAT Improved Performance	32



SMALLCALIBER

9 x 19 mm



NATO-qualified cartridge (AC/116-XVIIIB) for training and service, used in pistols and sub-machine guns.

 NATO BALL 124 gr

NORMATIVE REFERENCE	PROJECTILE TYPE	PROJECTILE WEIGHT	VELOCITY AT 16 m ^{1 2}
NATO AEP-97 ED A V1	FMJ	8.03 g / 124 gr	380 m/s / 1247 ft/s
ENERGY AT 16 m	CASE	SERVICE TEMPERATURE	SAFETY TEMPERATURE
580 J	BRASS	-54°C to +52°C -65°F to +125°F	-54°C to +71°C -65°F to +160°F



NATO standard cartridge for training and service, used in pistols and sub-machine guns.

 NATO BALL 115 gr

NORMATIVE REFERENCE	PROJECTILE TYPE	PROJECTILE WEIGHT	VELOCITY AT 16 m ^{1 2}
NATO AEP-97 ED A V1	FMJ	7.45 g / 115 gr	390 m/s / 1280 ft/s
ENERGY AT 16 m	CASE	SERVICE TEMPERATURE	SAFETY TEMPERATURE
567 J	BRASS	-54°C to +52°C -65°F to +125°F	-54°C to +71°C -65°F to +160°F

¹ Temperature: 21°C (70°F) | ² Test Barrel Length: 200 mm (7.8") | Transducer Type: 6215 Kistler

300 Blackout



Militarized ball cartridge for training and service. Manufactured according to SAAMI specifications and features additional military-spec characteristics such as NATO qualified energetics, full watertightness, visible annealing marks and superior ballistic performance.



Subsonic cartridge specially designed for suppressed weapons. Carefully selected propellant guarantees flawless functioning in all AR platforms, both pistol and carbine length gas systems. Base design according to SAAMI specifications and features additional military-spec characteristics such as NATO qualified energetics, full watertightness, visible annealing marks and superior ballistic performance.



Militarized Open Tip Match cartridge for training and service, featuring superior precision and terminal effects compared to ball version. Manufactured according to SAAMI and relevant military-spec characteristics, such as NATO qualified energetics, full watertightness and visible annealing marks.

FMJ 123 gr

PROJECTILE TYPE	PROJECTILE WEIGHT	VELOCITY AT 4.6 m ^{1 2}	ENERGY AT 4.6 m
FMJ	7.97 g - 123 gr	675 m/s - 2215 ft/s	1815 J
CASE	POINT OF IMPACT AT 100 m - 100 yd	POINT OF IMPACT AT 200 m - 200 yd	POINT OF IMPACT AT 300 m - 300 yd
BRASS	0 cm / 0 inch	-27.4 cm / -8.8 inch	-90.4 cm / -28.8 inch

FMJ SUBSONIC 200 gr

PROJECTILE TYPE	PROJECTILE WEIGHT	VELOCITY AT 4.6 m ^{1 2}	ENERGY AT 4.6 m
FMJ SUBSONIC	12.96 g - 200 gr	318 m/s 1043 ft/s	655 J
CASE	POINT OF IMPACT AT 100 m - 100 yd	POINT OF IMPACT AT 200 m - 200 yd	POINT OF IMPACT AT 300 m - 300 yd
BRASS	0 cm / 0 inch	-104.5 cm / -34.2 inch	-321.9 cm / -105 inch

OTM 115 gr

PROJECTILE TYPE	PROJECTILE WEIGHT	VELOCITY AT 4.6 m ^{1 2}	ENERGY AT 4.6 m
OPEN TIP MATCH	7.45 g - 115 gr	690 m/s - 2264 ft/s	1773 J
CASE	POINT OF IMPACT AT 100 m - 100 yd	POINT OF IMPACT AT 200 m - 200 yd	POINT OF IMPACT AT 300 m - 300 yd
BRASS	0 cm / 0 inch	-26.3 cm / -8.5 inch	-86.8 cm / -27.7 inch

¹ Temperature: 21°C (70°F) | ² Test Barrel Length: 406 mm (16")



5.56 x 45 mm

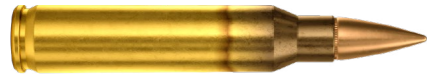

NATO-qualified cartridge equivalent to M855 and SS109. Suitable for weapons with 1:7 to 1:9 barrel twist, may also be offered linked with any other trajectory-matched cartridges, such as Tracer, IR Tracer and SAT, in different configurations.

NATO BALL

NORMATIVE REFERENCE	TIP IDENTIFICATION	PROJECTILE TYPE	PROJECTILE WEIGHT	VELOCITY AT 24 m ^{1 2}
NATO AEP-97 ED A V1	NONE	BALL	4.00 g / 62 gr	915 m/s / 3002 ft/s
ENERGY AT 24 m	CASE	SERVICE TEMPERATURE	SAFETY TEMPERATURE	BARREL TWIST
1675 J	BRASS	-54°C to +52°C -65°F to +125°F	-54°C to +71°C -65°F to +160°F	TW7

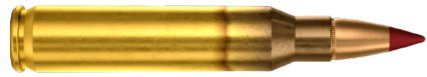

NATO standard tracer cartridge equivalent to M856 and L110, with full luminosity trace up to 600 m from the muzzle, visible in both day and night. Suitable for 5.56 x 45 mm weapons with a 1:7 to 1:9 barrel twist. May also be offered linked with any other trajectory-matched cartridges, such as Ball and/or SAT versions, in different configurations.

NATO TRACER

NORMATIVE REFERENCE	TIP IDENTIFICATION	PROJECTILE TYPE	PROJECTILE WEIGHT	VELOCITY AT 24 m ^{1 2}
NATO AEP-97 ED A V1	RED	TRACER	4.00 g / 62 gr	AS PER REFERENCE AMMUNITION
ENERGY AT 24 m	CASE	SERVICE TEMPERATURE	SAFETY TEMPERATURE	BARREL TWIST
≥ 1480 J	BRASS	-54°C to +52°C -65°F to +125°F	-54°C to +71°C -65°F to +160°F	TW7

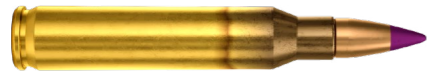

IR Tracer cartridges are meant for night operations, granting the combat forces a stealth advantage. The bullet trace is completely invisible to the naked eye and only visible with the use of Night Vision Devices (NVDs). Suitable for 5.56 x 45 mm weapons with 1:7 to 1:9 barrel twist. May also be offered linked with other trajectory-matched cartridges, such as Ball and/or SAT versions, in different configurations.

INFRARED TRACER [LEARN MORE ON PAGE 30](#)

NORMATIVE REFERENCE	TIP IDENTIFICATION	PROJECTILE TYPE	PROJECTILE WEIGHT	VELOCITY AT 24 m ^{1 2}
NATO AEP-97 ED A V1	LILAC	INFRARED TRACER	3.97 g / 61 gr	AS PER REFERENCE AMMUNITION
ENERGY AT 24 m	CASE	SERVICE TEMPERATURE	SAFETY TEMPERATURE	BARREL TWIST
≥ 1526 J	BRASS	-54°C to +52°C -65°F to +125°F	-54°C to +71°C -65°F to +160°F	TW7

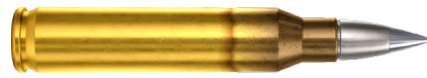

Improved performance cartridge suitable for 5.56 x 45 mm weapons with 1:7 to 1:9 barrel twist. It combines superior hard target penetration with better terminal effects than conventional 5.56 NATO Ball version. Loaded with a lead-free projectile, the 5.56 SAT provides more lethality at close-and-long-range engagements, up to 600 meters. May also be offered linked with trajectory-matched cartridges, such as Ball, Tracer and IR-Tracer, in different configurations.

SAT IMPROVED PERFORMANCE [LEARN MORE ON PAGE 32](#)

NORMATIVE REFERENCE	TIP IDENTIFICATION	PROJECTILE TYPE	PROJECTILE WEIGHT	VELOCITY AT 24 m ^{1 2}
NATO AEP-97 ED A V1	NONE	STEEL ARROW TIP (SAT)	4.0 g / 62 gr	900 m/s / 2953 ft/s
ENERGY AT 24 m	CASE	SERVICE TEMPERATURE	SAFETY TEMPERATURE	BARREL TWIST
1620 J	BRASS	-54°C to +52°C -65°F to +125°F	-54°C to +71°C -65°F to +160°F	TW7

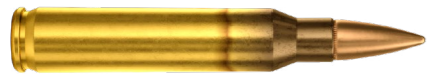

Standard Ball cartridge equivalent to M193. Suitable for weapons with 1:12 barrel twist, may be offered linked with Tracer version (M196).

BALL M193

NORMATIVE REFERENCE	TIP IDENTIFICATION	PROJECTILE TYPE	PROJECTILE WEIGHT	VELOCITY AT 24 m ^{1 2}
MIL-C-9963F	NONE	BALL	3.56 g / 55 gr	965 m/s / 3165 ft/s
ENERGY AT 24 m	CASE	SERVICE TEMPERATURE	SAFETY TEMPERATURE	BARREL TWIST
1658 J	BRASS	-54°C to +52°C -65°F to +125°F	-54°C to +71°C -65°F to +160°F	TW12

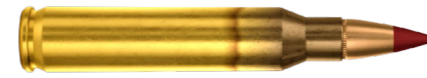

Standard tracer cartridge equivalent to M196, with full luminosity trace up to 450 m from the muzzle, visible in both day and night. Suitable for weapons with 1:12 barrel twist. May also be offered linked with 5.56 Ball M193, in different configurations.

TRACER M196

NORMATIVE REFERENCE	TIP IDENTIFICATION	PROJECTILE TYPE	PROJECTILE WEIGHT	VELOCITY AT 24 m ^{1 2}
MIL-C-60111C	RED	TRACER	3.35 g / 52 gr	AS PER REFERENCE AMMUNITION
ENERGY AT 24 m	CASE	SERVICE TEMPERATURE	SAFETY TEMPERATURE	BARREL TWIST
≥ 1512 J	BRASS	-54°C to +52°F -65°C to +125°F	-54°C to +71°F -65°C to +160°F	TW12

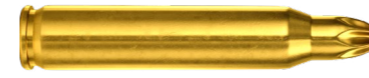

Standard Blank training cartridge equivalent to M200, may be used in standard and shorter magazines. Used with Blank Firing Attachment, it can be adjusted to all automatic weapons to provide consistent and reliable functioning.

BLANK SHORT

NORMATIVE REFERENCE	STAR CRIMP	CARTRIDGE LENGTH	CARTRIDGE WEIGHT	CASE	SERVICE TEMPERATURE
MIL-C-60616	6	48.5 mm / 1.91 inch	7.25 g / 112 gr NOMINAL	BRASS	-32°C to +52°C -26°F to +125°F



Standard Blank training cartridge equivalent to M51, may be used in standard and shorter magazines. Used with Blank Firing Attachment, it can be adjusted to all automatic weapons to provide consistent and reliable functioning.

BLANK INTERMEDIARY

NORMATIVE REFERENCE	STAR CRIMP	CARTRIDGE LENGTH	CARTRIDGE WEIGHT	CASE	SERVICE TEMPERATURE
MIL-C-60616	6	51 mm / 2 inch	7.6 g / 117 gr NOMINAL	BRASS	-32°C to +52°C -26°F to +125°F



Standard Blank cartridge for training. Used with Blank Firing Attachment, it can be adjusted to all automatic weapons to provide consistent and reliable functioning.

BLANK LONG

NORMATIVE REFERENCE	STAR CRIMP	CARTRIDGE LENGTH	CARTRIDGE WEIGHT	CASE	SERVICE TEMPERATURE
MIL-C-60616	4	56 mm / 2.2 inch	7.7 g / 119 gr NOMINAL	BRASS	-32°C to +52°C -26°F to +125°F

¹ Temperature: 21°C (70°F) | ² Test Barrel Length: 508 mm (20")



7.62 x 51 mm



NATO-qualified cartridge equivalent to M80. Suitable for all 7.62 x 51 mm weapons, may also be offered linked with any other trajectory-matched cartridges, such as Tracer, IR Tracer and AP, in different configurations.

NATO BALL

NORMATIVE REFERENCE	TIP IDENTIFICATION	PROJECTILE TYPE	PROJECTILE WEIGHT	VELOCITY AT 24 m ^{1 2}
NATO AEP-97 ED A V1	NONE	BALL	9.33 g / 144 gr	833 m/s / 2733 ft/s
ENERGY AT 24 m	CASE	SERVICE TEMPERATURE	SAFETY TEMPERATURE	BARREL TWIST
≥ 3237 J	BRASS	-54°C to +52°C -65°F to +125°F	-54°C to +71°C -65°F to +160°F	-



NATO standard tracer cartridge equivalent to M62, with full luminosity trace up to 775 m from the muzzle, visible in both day and night. Suitable for all 7.62 x 51 mm weapons. May also be offered linked with any other trajectory-matched cartridges, such as Ball and/or AP versions, in different configurations.

NATO TRACER

NORMATIVE REFERENCE	TIP IDENTIFICATION	PROJECTILE TYPE	PROJECTILE WEIGHT	VELOCITY AT 24 m ^{1 2}
NATO AEP-97 ED A V1	RED	TRACER	9.00 g / 139 gr	AS PER REFERENCE AMMUNITION
ENERGY AT 24 m	CASE	SERVICE TEMPERATURE	SAFETY TEMPERATURE	BARREL TWIST
≥ 2756 J	BRASS	-54°C to +52°C -65°F to +125°F	-54°C to +71°C -65°F to +160°F	-



IR Tracer cartridges are meant for night operations, granting the combat forces a stealth advantage. The bullet trace is completely invisible to the naked eye and only visible with the use of Night Vision Devices (NVDs). Suitable for all 7.62 x 51 mm weapons, it may be offered linked with any other trajectory-matched cartridges, such as Ball and/or AP, in different configurations.

INFRARED TRACER [LEARN MORE ON PAGE 30](#)

NORMATIVE REFERENCE	TIP IDENTIFICATION	PROJECTILE TYPE	PROJECTILE WEIGHT	VELOCITY AT 24 m ^{1 2}
NATO AEP-97 ED A V1	LILAC	INFRARED TRACER	9.00 g / 139 gr	AS PER REFERENCE AMMUNITION
ENERGY AT 24 m	CASE	SERVICE TEMPERATURE	SAFETY TEMPERATURE	BARREL TWIST
≥ 2756 J	BRASS	-54°C to +52°C -65°F to +125°F	-54°C to +71°C -65°F to +160°F	-



NATO standard armor-piercing cartridge equivalent to M61. Suitable for all 7.62 x 51 mm weapons, may be offered linked with any other trajectory-matched cartridges, such as Ball and Tracer, in different configurations.

NATO AP

NORMATIVE REFERENCE	TIP IDENTIFICATION	PROJECTILE TYPE	PROJECTILE WEIGHT	VELOCITY AT 24 m ^{1 2}
NATO AEP-97 ED A V1	BLACK	ARMOR-PIERCING	9.56 g / 148 gr	AS PER REFERENCE AMMUNITION
ENERGY AT 24 m	CASE	SERVICE TEMPERATURE	SAFETY TEMPERATURE	BARREL TWIST
≥ 2756 J	BRASS	-54°C to +52°C -65°F to +125°F	-54°C to +71°C -65°F to +160°F	-

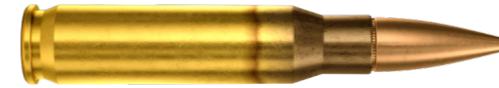

With higher accuracy performance, the 7.62 Match is suitable for use in precision rifles, as well as conventional weapons.

MATCH

NORMATIVE REFERENCE	TIP IDENTIFICATION	PROJECTILE TYPE	PROJECTILE WEIGHT	VELOCITY AT 24 m ^{1 2}
MIL-C-46934B	NONE	MATCH	10.49 g / 162 gr	750 m/s / 2461 ft/s
ENERGY AT 24 m	CASE	SERVICE TEMPERATURE	SAFETY TEMPERATURE	BARREL TWIST
≥ 2950 J	BRASS	-54°C to +52°C -65°F to +125°F	-54°C to +71°C -65°F to +160°F	-



Standard Blank training cartridge equivalent to M82. Used with Blank Firing Attachment, it can be adjusted to all automatic weapons to provide consistent and reliable functioning.

BLANK

NORMATIVE REFERENCE	STAR CRIMP	CARTRIDGE LENGTH	CARTRIDGE WEIGHT	CASE	SERVICE TEMPERATURE
MIL-C-46933	4	68.5 mm / 2.67 inch	13.4 g / 207 gr NOMINAL	BRASS	-32°C to +52°C -26°F to +125°F

¹ Temperature: 21°C (70°F) | ² Test Barrel Length: 560 mm (22")



12.7 x 99 mm



NATO-qualified cartridge equivalent to M33. Suitable for all 12.7 x 99 mm weapons, may also be offered linked with any other trajectory-matched cartridges, such as Tracer, AP, API and API-T, in different configurations.

★ NATO BALL

NORMATIVE REFERENCE	TIP IDENTIFICATION	PROJECTILE TYPE	PROJECTILE WEIGHT	VELOCITY AT 24 m ^{1 2}
NATO AEP-97 ED A V1	NONE	BALL	42.5 g / 656 gr	890 m/s / 2919,95 ft/s
ENERGY AT 24 m	CASE	SERVICE TEMPERATURE	SAFETY TEMPERATURE	BARREL TWIST
16336 J	BRASS	-54°C to +52°C -65°F to +125°F	-54°C to +71°C -65°F to +160°F	-



NATO standard tracer cartridge equivalent to M17, with full luminosity trace up to 1500 m from the muzzle, visible in both day and night. Suitable for all 12.7 x 99 mm weapons, it may be offered linked with any other trajectory-matched cartridges, such as Ball, AP and API, in different configurations.

★ NATO TRACER

NORMATIVE REFERENCE	TIP IDENTIFICATION	PROJECTILE TYPE	PROJECTILE WEIGHT	VELOCITY AT 24 m ^{1 2}
NATO AEP-97 ED A V1	RED	TRACER	40.8 g / 630 gr	AS PER REFERENCE AMMUNITION
ENERGY AT 24 m	CASE	SERVICE TEMPERATURE	SAFETY TEMPERATURE	BARREL TWIST
≥ 16523 J	BRASS	-54°C to +52°C -65°F to +125°F	-54°C to +71°C -65°F to +160°F	-



NATO standard armor-piercing cartridge. Suitable for all 12.7 x 99 mm weapons, it may be offered linked with any other trajectory-matched cartridges, such as Ball, Tracer, API and API-T, in different configurations.

★ NATO AP

NORMATIVE REFERENCE	TIP IDENTIFICATION	PROJECTILE TYPE	PROJECTILE WEIGHT	VELOCITY AT 24 m ^{1 2}
NATO AEP-97 ED A V1	BLACK	ARMOR-PIERCING	41.89 g / 646 gr	AS PER REFERENCE AMMUNITION
ENERGY AT 24 m	CASE	SERVICE TEMPERATURE	SAFETY TEMPERATURE	BARREL TWIST
≥ 16523 J	BRASS	-54°C to +52°C -65°F to +125°F	-54°C to +71°C -65°F to +160°F	-



NATO standard armor-piercing incendiary cartridge equivalent to M8. Suitable for all 12.7 x 99 mm weapons, it may be offered linked with any other trajectory-matched cartridges, such as Ball, Tracer, AP and API-T, in different configurations.

★ NATO API

NORMATIVE REFERENCE	TIP IDENTIFICATION	PROJECTILE TYPE	PROJECTILE WEIGHT	VELOCITY AT 24 m ^{1 2}
NATO AEP-97 ED A V1	ALUMINIUM	ARMOR-PIERCING INCENDIARY	42.7 g / 658 gr	AS PER REFERENCE AMMUNITION
ENERGY AT 24 m	CASE	SERVICE TEMPERATURE	SAFETY TEMPERATURE	BARREL TWIST
≥ 16775 J	BRASS	-54°C to +52°C -65°F to +125°F	-54°C to +71°C -65°F to +160°F	-



NATO standard armor-piercing incendiary tracer cartridge equivalent to M20. Suitable for all 12.7 x 99 mm weapons, it may be offered linked with any other trajectory-matched cartridges, such as Ball, Tracer, AP and API, in different configurations.

★ NATO API-T

NORMATIVE REFERENCE	TIP IDENTIFICATION	PROJECTILE TYPE	PROJECTILE WEIGHT	VELOCITY AT 24 m ^{1 2}
NATO AEP-97 ED A V1	RED AND ALUMINIUM	ARMOR-PIERCING INCENDIARY TRACER	40.4 g / 613 gr	AS PER REFERENCE AMMUNITION
ENERGY AT 24 m	CASE	SERVICE TEMPERATURE	SAFETY TEMPERATURE	BARREL TWIST
≥ 15603 J	BRASS	-54°C to +52°C -65°F to +125°F	-54°C to +71°C -65°F to +160°F	-



Standard Blank cartridge for training. Used with Blank Firing Attachment, it can be adjusted to all automatic weapons to provide consistent and reliable functioning.

BLANK

NORMATIVE REFERENCE	STAR CRIMP	CARTRIDGE LENGTH	CARTRIDGE WEIGHT	CASE	SERVICE TEMPERATURE
NATO AEP-97 ED A V1	6	98.9 mm / 3.89 inch	59.8 g / 923 gr NOMINAL	BRASS	-32°C to +52°C -26°F to +125°F

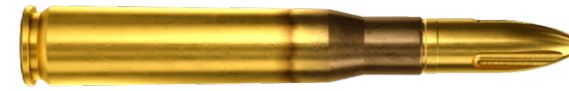

Ball Reduced Range cartridge was designed for use in space constrained firing ranges and sensitive populated surroundings. By reducing the overall Safety Danger Zone, the technology allows for training exercises closer to the quarters. It is also applicable for operational use, while mitigating the risk of collateral damage. Suitable for all 12.7 x 99 mm weapons, it may be offered linked with Tracer Reduced Range, in different configurations.

BALL REDUCED RANGE [LEARN MORE ON PAGE 28](#)

NORMATIVE REFERENCE	TIP IDENTIFICATION	PROJECTILE TYPE	PROJECTILE WEIGHT	VELOCITY AT 24 m ^{1 2}
NATO AEP-97 ED A V1 - HS / JXNN / C09 / 1630	NONE	BALL REDUCED RANGE	44.6 g / 688 gr	910 m/s / 2985 ft/s
ENERGY AT 24 m	CASE	SERVICE TEMPERATURE	SAFETY TEMPERATURE	BARREL TWIST
18425 J	BRASS	-54°C to +52°C -65°F to +125°F	-54°C to +71°C -65°F to +160°F	-



Tracer Reduced Range cartridge was designed for use in space constrained firing ranges and sensitive populated surroundings. By reducing the overall Safety Danger Zone, the technology allows for training exercises closer to the quarters. It is also applicable for operational use, while mitigating the risk of collateral damage. It provides full luminosity trace up to 1500 m from the muzzle, visible in both day and night. Suitable for all 12.7 x 99 mm weapons, it may be offered linked with Ball Reduced Range, in different configurations.

TRACER REDUCED RANGE [LEARN MORE ON PAGE 28](#)

NORMATIVE REFERENCE	TIP IDENTIFICATION	PROJECTILE TYPE	PROJECTILE WEIGHT	VELOCITY AT 24 m ^{1 2}
NATO AEP-97 ED A V1 - HS / JXNN / C09 / 1630	RED	TRACER REDUCED RANGE	42.5 g / 656 gr	AS PER REFERENCE AMMUNITION
ENERGY AT 24 m	CASE	SERVICE TEMPERATURE	SAFETY TEMPERATURE	BARREL TWIST
≥ 17597 J	BRASS	-54°C to +52°C -65°F to +125°F	-54°C to +71°C -65°F to +160°F	-

¹ Temperature: 21°C (70°F) | ² Test Barrel Length: 1143 mm (45")





SNIPER 1

SNIPER 1



High precision cartridge for sniper application. Loaded with Sierra MatchKing bullets, the .223 REM HPBT 69 gr is designed for use in sniper rifles, as well as conventional weapons.

.223 REM 69 gr HPBT

NORMATIVE REFERENCE	PROJECTILE TYPE	PROJECTILE WEIGHT
ANSI/SAAMI Z-2299.4 – 1992	HPBT	4.47 g - 69 gr
WATERTIGHTNESS	SERVICE TEMPERATURE	SAFETY TEMPERATURE
YES	-20°C to +40°C -4°F to +104°F	-54°C to +71°C -65°F to 160°F



High precision cartridge for long range sniper application. Loaded with Sierra MatchKing bullets, the .223 REM HPBT 77 gr is designed for use in sniper rifles, as well as conventional weapons.

.223 REM 77 gr HPBT

NORMATIVE REFERENCE	PROJECTILE TYPE	PROJECTILE WEIGHT
ANSI/SAAMI Z-2299.4 – 1992	HPBT	4.99 g - 77 gr
WATERTIGHTNESS	SERVICE TEMPERATURE	SAFETY TEMPERATURE
YES	-20°C to +40°C -4°F to +104°F	-54°C to +71°C -65°F to 160°F



High precision cartridge for sniper application. Loaded with Sierra MatchKing bullets, the .308 HPBT 168 gr is designed for use in sniper rifles, as well as conventional weapons.

.308 WIN 168 gr HPBT

NORMATIVE REFERENCE	PROJECTILE TYPE	PROJECTILE WEIGHT
ANSI/SAAMI Z-2299.4 – 1992	HPBT	10.89 g - 168 gr
WATERTIGHTNESS	SERVICE TEMPERATURE	SAFETY TEMPERATURE
YES	-20°C to +40°C -4°F to +104°F	-54°C to +71°C -65°F to 160°F



High precision cartridge for long range sniper application. Loaded with Berger VLD bullets, the .308 HPBT 175 gr is designed for use in sniper rifles, as well as conventional weapons.

.308 WIN 175 gr HPBT

NORMATIVE REFERENCE	PROJECTILE TYPE	PROJECTILE WEIGHT
ANSI/SAAMI Z-2299.4 – 1992	HPBT	11.34 g - 175 gr
WATERTIGHTNESS	SERVICE TEMPERATURE	SAFETY TEMPERATURE
YES	-20°C to +40°C -4°F to +104°F	-54°C to +71°C -65°F to 160°F

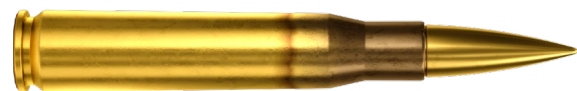

Ball Solid Sniper is a high precision cartridge for long range shooting. It is designed for use in all 12.7 x 99 mm sniper rifles and guarantees precision of less than 1 MOA at 1000 m.

.50 BALL SOLID

NORMATIVE REFERENCE	PROJECTILE TYPE	PROJECTILE WEIGHT
NATO AEP-97 ED A V1	BALL SOLID	49.9 g - 770 gr
WATERTIGHTNESS	SERVICE TEMPERATURE	SAFETY TEMPERATURE
YES	-54°C to +52°C -65°F to +125°F	-54°C to +71°C -65°F to 160°F

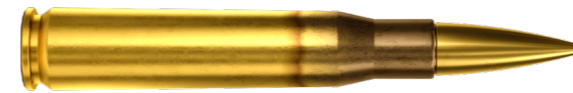

AP Solid Sniper is a high precision armor-piercing cartridge for long range shooting against protected targets. It is designed for use in all 12.7 x 99 mm sniper rifles and guarantees precision of less than 2 MOA at 1000 m. It perforates 22 mm RHA steel plates at 100 m.

.50 AP SOLID

NORMATIVE REFERENCE	PROJECTILE TYPE	PROJECTILE WEIGHT
NATO AEP-97 ED A V1	ARMOR-PIERCING SOLID	50.15 g - 774 gr
WATERTIGHTNESS	SERVICE TEMPERATURE	SAFETY TEMPERATURE
YES	-54°C to +52°C -65°F to +125°F	-54°C to +71°C -65°F to 160°F

BALLISTIC TABLE

PRODUCT	VELOCITY AT 24m ¹ (m/s) / (ft/s)	ENERGY AT 24m (J)	BARREL LENGTH (mm) / (inch)	BARREL TWIST	POINT OF IMPACT (cm) / (inch)					PRECISION (MAX. MOA)	BALLISTIC COEFFICIENT	SECTIONAL DENSITY
					200 m	400 m	600 m	800 m	1000 m			
.223 REM 69 gr HPBT	860 / 2822	1653	610 / 24"	TW7	-16.8 / -6.6	-122.6 / -48.3	-386.5 / -152.1	-928.1 / -365.4	-1858 / -731.5	2	0.305	0.196
.223 REM 77 gr HPBT	800 / 2625	1597	610 / 24"	TW7	-18.8 / -7.4	-133 / -52.4	-400.8 / -157.8	-922 / -363.0	-1800 / -708.7	2	0.362	0.219
.308 WIN 168 gr HPBT	800 / 2625	3485	610 / 24"	TW12	-17.9 / -7.0	-121.9 / -48.0	-349.9 / -137.8	-761.6 / -299.8	-1442.7 / -568.0	1	0.462	0.253
.308 WIN 175 gr HPBT	800 / 2625	3629	610 / 24"	TW12	-17.7 / -7.0	-119.3 / -47.0	-338.4 / -133.2	-726.4 / -286.0	-1358.3 / -534.8	1.5	0.496	0.264
.50 BALL 770 gr SOLID	850 / 2789	18026	1143 / 45"	TW15	-14.35 / -5.6	-90.55 / -35.6	-238.5 / -93.9	-470.3 / -185.2	-800.4 / -315.1	1	1.018	0.44
.50 AP 774 gr SOLID	856 / 2808	18373	1143 / 45"	TW15	-14.2 / -5.6	-89.3 / -35.2	-235.1 / -92.6	-463.5 / -182.5	-788.5 / -310.4	2	1.018	0.442

¹ Temperature: 21°C (70°F)





- HV B
38 C 10

MEDIUMCALIBER

20 x 102 mm



Training cartridge equivalent to M55A2. Suitable for use in M39 and M61 cannons. It may be offered linked with the TP-T version, in different configurations.

TP

NORMATIVE REFERENCE	PROJECTILE TYPE	PROJECTILE WEIGHT	VELOCITY AT 7.5 m ^{1,2}
MIL-C-46552C	TARGET PRACTICE	98.5 g / 1520 gr	1000 m/s / 3281 ft/s
ENERGY AT 7.5 m	CASE	WATERTIGHTNESS	SERVICE TEMPERATURE
49250 J	BRASS	YES	-54°C to +21°C -65°F to 125°F



Traced training cartridge equivalent to M220. Suitable for use in M39 and M61 cannons. It may be offered linked with the TP version, in different configurations.

TP-T

NORMATIVE REFERENCE	PROJECTILE TYPE	PROJECTILE WEIGHT	VELOCITY AT 7.5 m ^{1,2}
MIL-C-60609A	TARGET PRACTICE TRACER	98.5 g / 1520 gr	1000 m/s / 3281 ft/s
ENERGY AT 7.5 m	CASE	WATERTIGHTNESS	SERVICE TEMPERATURE
49250 J	BRASS	YES	-54°C to +21°C -65°F to 125°F



Armor-piercing incendiary operational cartridge equivalent to M53. Suitable for use in M39 and M61 cannons.

API

NORMATIVE REFERENCE	PROJECTILE TYPE	PROJECTILE WEIGHT	VELOCITY AT 7.5 m ^{1,2}
MIL-C-46552C	ARMOR-PIERCING INCENDIARY	100.5 g / 1551 gr	1000 m/s / 3281 ft/s
ENERGY AT 7.5 m	CASE	WATERTIGHTNESS	SERVICE TEMPERATURE
50250 J	BRASS	YES	-54°C to +21°C -65°F to 125°F



High explosive incendiary operational cartridge equivalent to M56A3. Suitable for use in M39 and M61 cannons.

HEI

NORMATIVE REFERENCE	PROJECTILE TYPE	PROJECTILE WEIGHT	VELOCITY AT 7.5 m ^{1,2}
MIL-C-46578D	HIGH EXPLOSIVE INCENDIARY	100.5 g / 1551 gr	1000 m/s / 3281 ft/s
ENERGY AT 7.5 m	CASE	WATERTIGHTNESS	SERVICE TEMPERATURE
50250 J	BRASS	YES	-54°C to +21°C -65°F to 125°F

¹ Temperature: 21°C (70°F) | ² Test Barrel Length: 1361 mm (53.4/7")

20 x 128 mm



Training cartridge suitable for use in KAA-KAB cannons. It may be offered linked with the TP-T version, in different configurations.

TP

NORMATIVE REFERENCE	PROJECTILE TYPE	PROJECTILE WEIGHT	VELOCITY AT 7.5 m ^{1,2}
MIL-C-46578D	TARGET PRACTICE	125 g / 1929 gr	1035 m/s / 3396 ft/s
ENERGY AT 7.5 m	CASE	WATERTIGHTNESS	SERVICE TEMPERATURE
66952 J	STEEL	YES	-54°C to +21°C -65°F to 125°F



Traced training cartridge suitable for use in KAA-KAB cannons. It may be offered linked with the TP version, in different configurations.

TP-T

NORMATIVE REFERENCE	PROJECTILE TYPE	PROJECTILE WEIGHT	VELOCITY AT 7.5 m ^{1,2}
MIL-C-46578D	TARGET PRACTICE TRACER	125 g / 1929 gr	1035 m/s / 3396 ft/s
ENERGY AT 7.5 m	CASE	WATERTIGHTNESS	SERVICE TEMPERATURE
66952 J	STEEL	YES	-54°C to +21°C -65°F to 125°F



High explosive incendiary operational cartridge suitable for use in KAA-KAB cannons. It may be offered linked with the HEI-T version, in different configurations.

HEI

NORMATIVE REFERENCE	PROJECTILE TYPE	PROJECTILE WEIGHT	VELOCITY AT 7.5 m ^{1,2}
MIL-C-46578D	HIGH EXPLOSIVE INCENDIARY	125 g / 1929 gr	1035 m/s / 3396 ft/s
ENERGY AT 7.5 m	CASE	WATERTIGHTNESS	SERVICE TEMPERATURE
66952 J	STEEL	YES	-54°C to +21°C -65°F to 125°F



High explosive incendiary tracer operational cartridge suitable for use in KAA-KAB cannons. It may be offered linked with the HEI version, in different configurations.

HEI-T

NORMATIVE REFERENCE	PROJECTILE TYPE	PROJECTILE WEIGHT	VELOCITY AT 7.5 m ^{1,2}
MIL-C-46578D	HIGH EXPLOSIVE INCENDIARY TRACER	122.5 g / 1890 gr	1035 m/s / 3396 ft/s
ENERGY AT 7.5 m	CASE	WATERTIGHTNESS	SERVICE TEMPERATURE
65613 J	STEEL	YES	-54°C to +21°C -65°F to 125°F



High explosive incendiary tracer, self-destructive operational cartridge suitable for use in KAA-KAB cannons. It may be offered linked with the HEI version, in different configurations.

HEI-T-SD

NORMATIVE REFERENCE	PROJECTILE TYPE	PROJECTILE WEIGHT	VELOCITY AT 7.5 m ^{1,2}
MIL-C-46578D	HIGH EXPLOSIVE INCENDIARY SELF-DESTRUCTIVE	125 g / 1929 gr	1035 m/s / 3396 ft/s
ENERGY AT 7.5 m	CASE	WATERTIGHTNESS	SERVICE TEMPERATURE
66952 J	STEEL	YES	-54°C to +21°C -65°F to 125°F

¹ Temperature: 21°C (70°F) | ² Test Barrel Length: 1700 mm (67")

30 x 113 mm



Training cartridge suitable for use in DEFA automatic cannon. It may be offered linked with the TP-T version, in different configurations.

TP

NORMATIVE REFERENCE	PROJECTILE TYPE	PROJECTILE WEIGHT	VELOCITY AT 7.5 m ^{1,2}
MIL-C-46578D	TARGET PRACTICE	245 g / 3781 gr	810 m/s / 2657 ft/s
ENERGY AT 7.5 m	CASE	WATERTIGHTNESS	SERVICE TEMPERATURE
80372 J	STEEL	YES	-54°C to +52°C -65°F to +125°F



Traced training cartridge suitable for use in DEFA automatic cannon. It may be offered linked with the TP version, in different configurations.

TP-T

NORMATIVE REFERENCE	PROJECTILE TYPE	PROJECTILE WEIGHT	VELOCITY AT 7.5 m ^{1,2}
MIL-C-46578D	TARGET PRACTICE TRACER	245 g / 3781 gr	810 m/s / 2657 ft/s
ENERGY AT 7.5 m	CASE	WATERTIGHTNESS	SERVICE TEMPERATURE
80372 J	STEEL	YES	-54°C to +52°C -65°F to +125°F



Armor-piercing incendiary operational cartridge. Suitable for use in DEFA cannon.

API

NORMATIVE REFERENCE	PROJECTILE TYPE	PROJECTILE WEIGHT	VELOCITY AT 7.5 m ^{1,2}
MIL-C-46578D	ARMOR-PIERCING INCENDIARY	275 g / 4244 gr	780 m/s / 2559 ft/s
ENERGY AT 7.5 m	CASE	WATERTIGHTNESS	SERVICE TEMPERATURE
83655 J	STEEL	YES	-54°C to +52°C -65°F to +125°F



High explosive incendiary, self-destructive operational cartridge. Suitable for use in DEFA automatic cannon.

HEI-SD

NORMATIVE REFERENCE	PROJECTILE TYPE	PROJECTILE WEIGHT	VELOCITY AT 7.5 m ^{1,2}
MIL-C-46578D	HIGH EXPLOSIVE INCENDIARY SELF-DESTRUCTIVE	242 g / 3735 gr	810 m/s / 2657 ft/s
ENERGY AT 7.5 m	CASE	WATERTIGHTNESS	SERVICE TEMPERATURE
79388 J	STEEL	YES	-54°C to +52°C -65°F to +125°F

¹ Temperature: 21°C (70°F) | ² Test Barrel Length: 1400 mm (55")

30 x 173 mm



Traced training cartridge suitable for use in Bushmaster II Mk44 and Mauser MK30 weapon systems.

TP-T

NORMATIVE REFERENCE	PROJECTILE TYPE	PROJECTILE WEIGHT	VELOCITY AT 7.5 m ^{1,2}
PPF(NAAG)D (2010)0011	TARGET PRACTICE TRACER	380 g / 5864 gr	1080 m/s / 3543 ft/s
ENERGY AT 7.5 m	CASE	WATERTIGHTNESS	SERVICE TEMPERATURE
221616 J	STEEL	YES	-54°C to +52°C -65°F to +125°F



High explosive incendiary operational cartridge suitable for use in Bushmaster and Mauser MK30 weapon systems.

HEI

NORMATIVE REFERENCE	PROJECTILE TYPE	PROJECTILE WEIGHT	VELOCITY AT 7.5 m ^{1,2}
PPF(NAAG)D (2010)0011	HIGH EXPLOSIVE INCENDIARY	370 g / 5710 gr	1080 m/s / 3543 ft/s
ENERGY AT 7.5 m	CASE	WATERTIGHTNESS	SERVICE TEMPERATURE
215784 J	STEEL	YES	-54°C to +52°C -65°F to +125°F

¹ Temperature: 21°C (70°F) | ² Test Barrel Length: 3000 mm (118,1/9")



40 x 53 mm HIGH VELOCITY AMMUNITION



Training cartridge suitable for use in Mk19 Mod 3, H&K GMG and other Automatic Grenade Launchers. It may be offered linked with the TP-T version, in different configurations.

TP

NORMATIVE REFERENCE	CARTRIDGE LENGTH	CARTRIDGE WEIGHT	MUZZLE VELOCITY
AC/225 (LG/3 - SG/1) D/17	112 mm / 4.41 inch	375 g / 5787 gr NOMINAL	242 m/s / 794 ft/s
FUZE		CAPABILITY	
-		TRAJECTORY MATCHING HE VERSIONS	



High explosive operational cartridge with blast and fragmentation capabilities, providing a lethal radius of 5 meters. Suitable for use in Mk19 Mod 3, H&K GMG and other Automatic Grenade Launchers. It may be offered linked with the HEDP version, in different configurations.

HE

NORMATIVE REFERENCE	CARTRIDGE LENGTH	CARTRIDGE WEIGHT	MUZZLE VELOCITY
AC/225 (LG/3 - SG/1) D/17	112 mm / 4.41 inch	375 g / 5787 gr NOMINAL	242 m/s / 794 ft/s
FUZE		CAPABILITY	
POINT-DETONATING		BLAST WITH FRAGMENTATION	



Traced training cartridge suitable for use in Mk19 Mod 3, H&K GMG and other Automatic Grenade Launchers. It may be offered linked with the TP version, in different configurations.

TP-T

NORMATIVE REFERENCE	CARTRIDGE LENGTH	CARTRIDGE WEIGHT	MUZZLE VELOCITY
AC/225 (LG/3 - SG/1) D/17	112 mm / 4.41 inch	375 g / 5787 gr NOMINAL	242 m/s / 794 ft/s
FUZE		CAPABILITY	
-		TRAJECTORY MATCHING HE VERSIONS TRACE OF MINIMUM 7 SECONDS	



High explosive operational cartridge with self-destruct capability with reliability over 99%. Projectile blast and fragmentation effect provides a lethal radius of 5 meters. Suitable for use in Mk19 Mod 3, H&K GMG and other Automatic Grenade Launchers. It may be offered linked with the HEDP-SD version, in different configurations.

HE-SD

NORMATIVE REFERENCE	CARTRIDGE LENGTH	CARTRIDGE WEIGHT	MUZZLE VELOCITY
AC/225 (LG/3 - SG/1) D/17	112 mm / 4.41 inch	375 g / 5787 gr NOMINAL	242 m/s / 794 ft/s
FUZE		CAPABILITY	
POINT-DETONATING WITH SELF-DESTRUCT		BLAST WITH FRAGMENTATION AND SELF-DESTRUCT	



Modern training cartridge with highly visible impact signature, designed to provide realistic training exercises during daytime without risk of generating unexploded ordnance and range fires. Suitable for use in Mk19 Mod 3, H&K GMG and other Automatic Grenade Launchers. It may be offered linked with the TP-DM-T version, in different configurations.

TP-DM

NORMATIVE REFERENCE	CARTRIDGE LENGTH	CARTRIDGE WEIGHT	MUZZLE VELOCITY
AC/225 (LG/3 - SG/1) D/17	112 mm / 4.41 inch	375 g / 5787 gr NOMINAL	242 m/s / 794 ft/s
FUZE		CAPABILITY	
-		TRAJECTORY MATCHING HE VERSIONS. VISUAL SIGNATURE UPON IMPACT (ORANGE CLOUD)	



High explosive dual purpose operational cartridge provides simultaneously a lethal blast and fragment radius of 5 meters and armor penetration greater than 50 mm RHA. Suitable for use in Mk19 Mod 3, H&K GMG and other Automatic Grenade Launchers. It may be offered linked with the HE version, in different configurations.

HEDP

NORMATIVE REFERENCE	CARTRIDGE LENGTH	CARTRIDGE WEIGHT	MUZZLE VELOCITY
AC/225 (LG/3 - SG/1) D/17	112 mm / 4.41 inch	375 g / 5787 gr NOMINAL	242 m/s / 794 ft/s
FUZE		CAPABILITY	
POINT-DETONATING		BLAST WITH FRAGMENTATION PENETRATE MINIMUM 50 mm RHA PLATE	



Modern traced training cartridge with highly visible impact signature, designed to provide realistic training exercises during daytime without risk of unexploded ordnance generation. Suitable for use in Mk19 Mod 3, H&K GMG and other Automatic Grenade Launchers. It may be offered linked with the TP-DM version, in different configurations.

TP-DM-T

NORMATIVE REFERENCE	CARTRIDGE LENGTH	CARTRIDGE WEIGHT	MUZZLE VELOCITY
AC/225 (LG/3 - SG/1) D/17	112 mm / 4.41 inch	375 g / 5787 gr NOMINAL	242 m/s / 794 ft/s
FUZE		CAPABILITY	
-		TRAJECTORY MATCHING HE VERSIONS VISUAL SIGNATURE UPON IMPACT (ORANGE CLOUD) TRACE OF MINIMUM 7 SECONDS	



High explosive dual purpose operational cartridge with self-destruct capability with reliability over 99%. Projectile blast and fragmentation effect provides a lethal radius of 5 meters and armor penetration greater than 50 mm RHA. Suitable for use in Mk19 Mod 3, H&K GMG and other Automatic Grenade Launchers. It may be offered linked with the HE-SD version, in different configurations.

HEDP-SD

NORMATIVE REFERENCE	CARTRIDGE LENGTH	CARTRIDGE WEIGHT	MUZZLE VELOCITY
AC/225 (LG/3 - SG/1) D/17	112 mm / 4.41 inch	375 g / 5787 gr NOMINAL	242 m/s / 794 ft/s
FUZE		CAPABILITY	
POINT-DETONATING WITH SELF-DESTRUCT		BLAST WITH FRAGMENTATION AND SELF-DESTRUCT PENETRATE MINIMUM 50 mm RHA PLATE	

¹ Temperature: 21°C (70°F) | ² Test Barrel Length: 434 m (17")



SPECIAL TECHNOLOGIES

REDUCED RANGE

INTRODUCTION

CBC Reduced Range (RR) ammunition was design for tactical operations in sensitive populated surrounding and for training in space constrained firing ranges. By reducing the overall Safety Danger Zone (SDZ), the technology mitigates risk of collateral damage and provides greater logistic efficiency and range availability.

CBC .50 cal RR Ball and Tracer comply with 7.62 x 51 mm M80 safety template, with maximum range not exceeding 3.500 m, or half of the maximum range comparing to the standard .50 NATO Ball ammunition. Both RR Ball and Tracer have matching ballistic trajectories with standard .50 NATO Ball up to 900 m (figure 1).

The product performance is achieved due to a special aerodynamic bullet design, that causes the projectile's spin velocity to decrease during flight, progressively reducing its gyroscopic and dynamic stability.

The CBC .50 cal RR cartridges were successfully tested against the complete NATO qualification program and have been fielded by several NATO and allied countries.

Figure 1 - Maximum range comparison between .50 caliber (RR) and .50 NATO caliber.

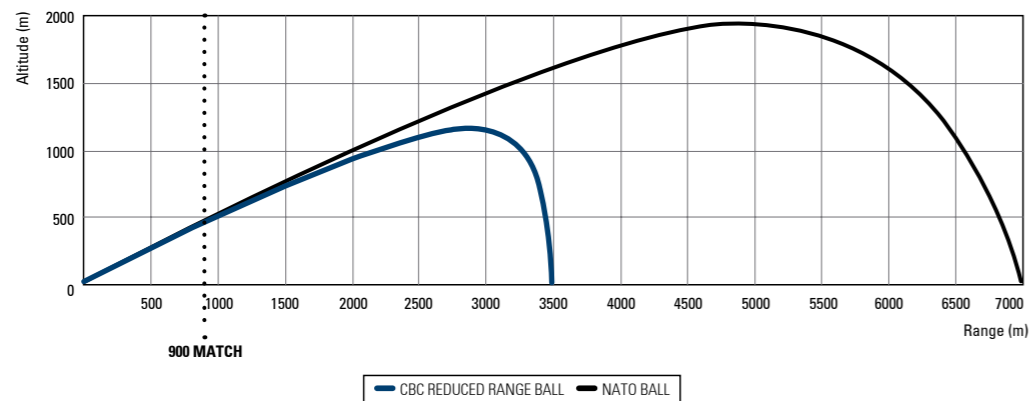

COMPOSITION

1	PROJECTILE BALL	MONOLITHIC BRASS BULLET FRONTAL FLUTES
2	PROJECTILE TRACER	MONOLITHIC BRASS BULLET FRONTAL FLUTES RED TIP IDENTIFICATION
3	TRACE PERFORMANCE	UP TO 1500 m
4	CASE	BRASS (CU ₇₀ ZN ₃₀)
5	PROPELLANT	SINGLE BASE, REACH COMPLIANT
6	PRIMER	PERCUSSION, BOXER TYPE, CRIMPED AND SEALED

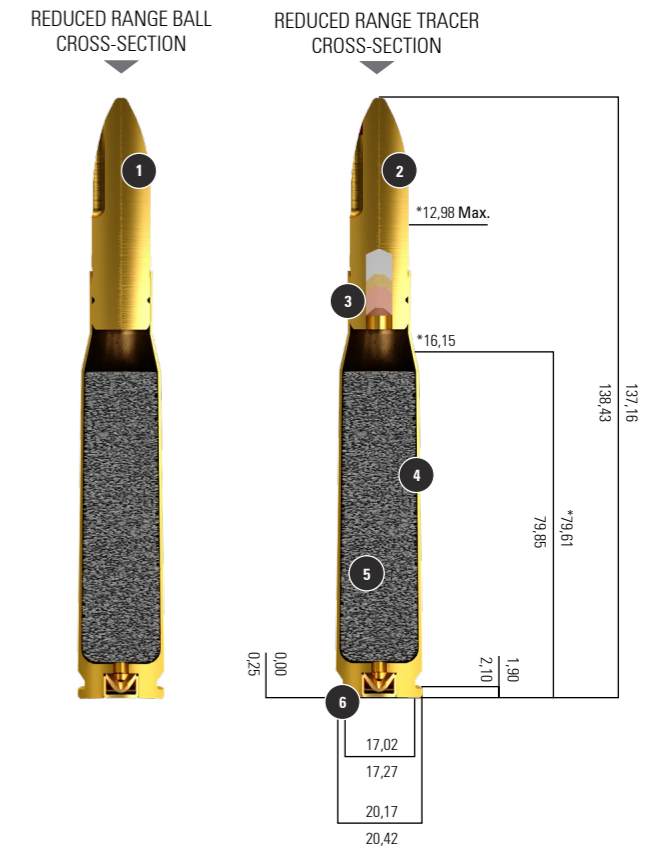

⊕ Fully compatible with all NATO nominated weapons or equivalents without the need of any modifications or auxiliary equipment.



ADVANTAGES

- Applicable for tactical operations, decreasing risk of collateral damage;
- Solid projectile can penetrate light barriers and unarmored structures in urban combat scenarios;
- Allows training in smaller firing ranges (7.62 x 51 mm M80 Surface Danger Zone);
- Simultaneous training by multiple units at the same training facility, when space permits;
- Logistics efficiency in allowing training to occur closer to the quarters, reducing costs;
- Trace visibility up to 1500 meters;
- No weapon modification or conversion kit required;
- Compliant with NATO Small Caliber MOPI.



INFRARED TRACER

INTRODUCTION

CBC IR Tracer ammunition was designed for night operations, granting the combat forces a stealth advantage. The bullet trace is completely invisible to the naked eye and only visible with the use of Night Vision Devices (NVDs).

The technology gives the shooter higher engagement effectiveness since the target visualization is not ofuscated by the halo effect. With the use of a special propellant that virtually eliminates muzzle flash, it allows a tactical upper hand by keeping the shooter's position unexposed.

The trace performance is achieved due to a special tracer composition that keeps the wave length emission within the IR spectrum, therefore visible only through NVDs – GEN 3 and beyond.

CBC IR Tracer complies with STANAGs 2310 (for the 7.62 mm) and 4172 (for the 5.56 mm), as well as with NATO (Multi-caliber MOPI Standard). The ballistic trajectories for both 5.56 and 7.62 IR match NATO reference cartridges, making them interchangeable with regular tracers.

ADVANTAGES

- Invisible to the naked eye;
- Trace visible from the shooter's position and only through night-vision devices (NVDs) – GEN 3 and beyond;
- Reduced halo effect, enhancing engagement capability;
- Shooter's position remains unexposed;
- Fully compliant with NATO MOPI requirements;
- No weapon modification or conversion kit is required.



REDUCED SIGNATURE

The reduced signature advantage is granted by the special energetic components' properties, which ensure that the trace remains invisible to the naked eye and with virtually zero muzzle flash.

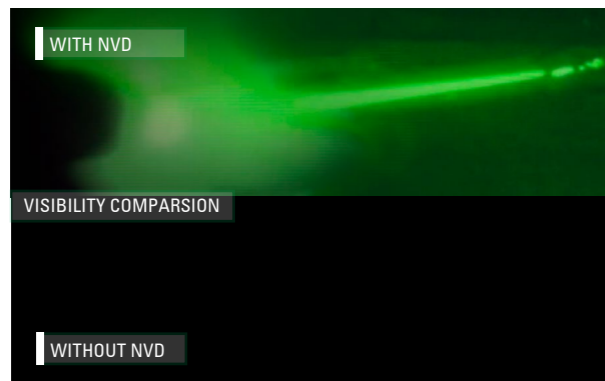

■ Footage of CBC 7.62 IR Tracer testing in cooperation with Brazilian Air Force Black Hawk (UH-60) Helicopter armed with M134 Gatling gun "Minigun".

HALO EFFECT

Differently from the standard tracer ammunition, CBC IR Tracer ammunition allows the fighter to clearly see the bullet's trajectory without super exposing the NVD sensors (image intensifier tube), problem also known as "halo effect" – a bright spot that can be several times bigger than the actual target, partially blocking the shooter's line of sight, compromising accuracy and combat effectiveness.

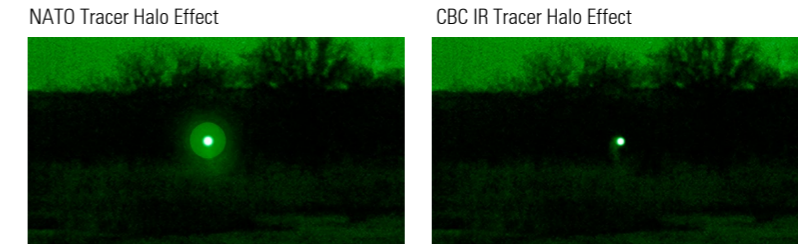

COMPOSITION

1	PROJECTILE 5.56 mm	COPPER CLAD STEEL JACKET
2	PROJECTILE 7.62 mm	GILDING / CLAD METAL JACKET
3	TRACER COMPOSITION	LOW SPECTRUM IR TECHNOLOGY
4	CASE	BRASS (Cu ₁₀ Zn ₉₀) (UNS 26000)
5	PROPELLANT	DOUBLE BASE, REACH COMPLIANT
6	PRIMER	PERCUSSION, BOXER TYPE, CRIMPED AND SEALED

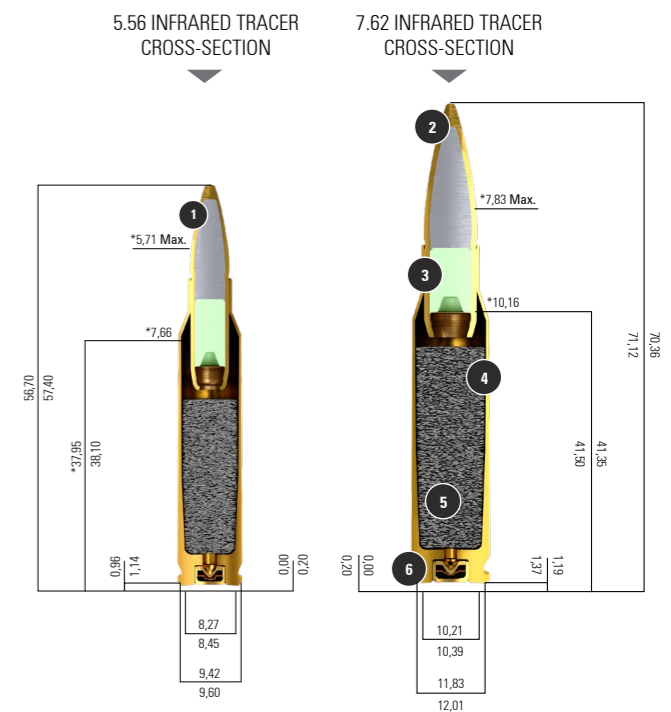

⊕ Fully compatible with all NATO nominated weapons or equivalents without the need of any modifications or auxiliary equipment.



SAT IMPROVED PERFORMANCE

INTRODUCTION

CBC 5.56 x 45 mm SAT Improved Performance combines superior hard target penetration with better terminal effects than conventional 5.56 NATO Ball ammunition. Loaded with a lead-free projectile the 5.56 SAT provides the infantry more consistent lethality at close-and-long-range engagements, up to 600 meters.

The improved performance is a result of the projectile capability of penetrating barriers with higher effectiveness and carrying enough residual energy to incapacitate soft targets. In direct shots, the projectile construction favors fragmentation and increases lethality.

Although lighter, the 5.56 SAT outperforms the 7.62 Ball M80 in both hard and soft targets. The 5.56 SAT will completely perforate a 9.5 mm thick mild steel plate at a distance of 385 meters from muzzle, still having enough residual energy to guarantee effective terminal performance.

Designed to comply with the STANAG 4172 and NATO (Multi-caliber MOPI Standard), CBC 5.56 x 45 mm SAT ballistic trajectories fully match NATO reference cartridges.

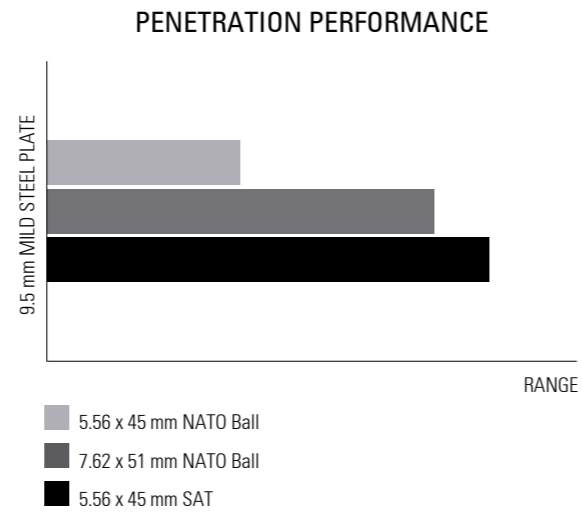

COMPOSITION

1	PROJECTILE	COPPER SOLID BODY EXPOSED STEEL CORE LEAD FREE
2	PENETRATION PERFORMANCE	9.5 mm STEEL PLATE (SAE 1010 OR 1020 55 HRB - 70 HRB), AT 385 m FROM MUZZLE
3	CASE	BRASS (Cu ₇₀ Zn ₃₀) (UNS 26000)
4	PROPELLANT	DOUBLE BASE, REACH COMPLIANT
5	PRIMER	PERCUSSION, BOXER TYPE, CRIMPED AND SEALED

SAT IMPROVED PERFORMANCE CROSS-SECTION

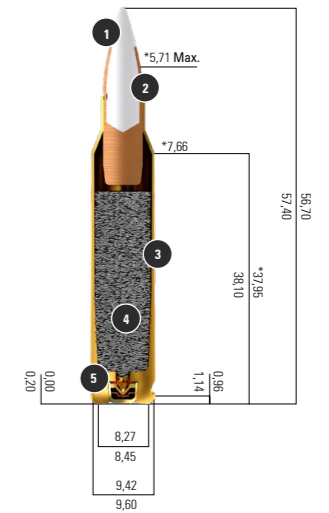

ADVANTAGES

- Improved hard target performance and increased terminal effect against soft targets – compared to 5.56 x 45 mm NATO Ball;
- Effective against a wide variety of targets;
- Increases the engagement range to distances up to 600 m;
- Lead free projectile;
- Bullet coating for reducing barrel wear;
- No weight increase compared to 5.56 x 45 mm NATO Ball;
- Fully compliant with NATO MOPI requirements;
- No weapon modification or conversion kit is required.



COMPARISON CHART

5.56 NATO BALL VS. 5.56 SAT

CHARACTERISTICS	NATO BALL	SAT
CARTRIDGE LENGTH (mm)	56.70 – 57.40	56.70 – 57.40
BULLET WEIGHT (g)	3.9 – 4.1	3.9 – 4.1
SLUG	LEAD	COPPER
PENETRATOR	HARDENED STEEL	HIGH HARDENED STEEL
PENETRATION	4.75 mm MILD STEEL PLATE (1010 OR 1020, BETWEEN 55 AND 70 HRB) AT 450 m	9.5 mm MILD STEEL PLATE (1010 OR 1020, BETWEEN 55 AND 75 HRB) AT 385 m

⊕ Fully compatible with all NATO nominated weapons or equivalents without the need of any modifications or auxiliary equipment.



LEARN MORE ABOUT CBC DEFENSE, GLOBAL LEADER IN THE AMMUNITION SEGMENT

STATUS

- ◆ Among the three largest ammunition producers in the World
- ◆ One of the main suppliers to NATO and allied forces
- ◆ Operations in Brazil, Germany, USA and Czech Republic



GLOBAL PRESENCE

- ◆ Present in more than 100 countries
- ◆ Serving military forces in over 50 countries
- ◆ Preferred supplier to several private and military OEMs, worldwide

PRODUCTION

- ◆ Largest private manufacturer of .50 ammunition
- ◆ Pioneer ammunition producer with LEAN system
- ◆ Fully integrated production site and self-sufficient in technology
- ◆ Flexible production lines, convertible to different calibers



A member of  GLOBAL
AMMUNITION

Av. Humberto de Campos, 3220 - 09426 900 - Ribeirão Pires - São Paulo - Brazil
Phone: +55 11 2139 8219 - cbcdefense.com